

RHINO-RACK

CONTROLLED

RCP32-BK Holden Colorado 7 - Chevrolet Trailblazer - LDV D90

- Important:**
- 1. Please refer to your fitting instruction to ensure that the roof racks are installed in the correct locations.
 - 2. Check the contents of kit before commencing fitment and report any discrepancies.
 - 3. Place these instructions in the vehicle's glove box after installation is complete.
 - 4. These instructions must be followed for warranty to be upheld.

Layout:

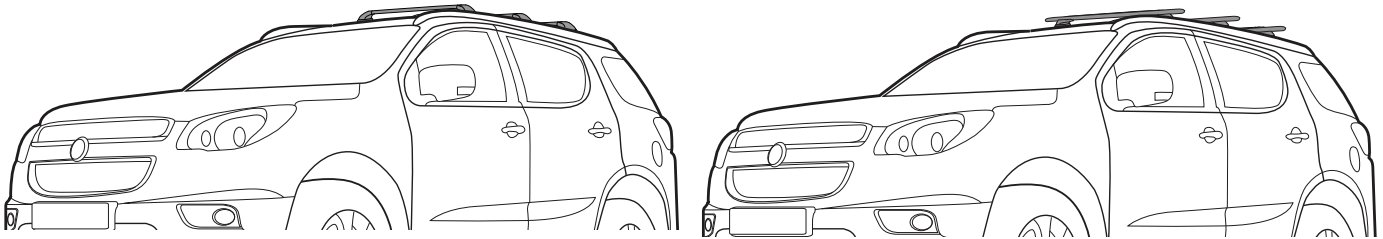

Note: Crossbars and legs sold as separate.

Important Information

Vehicle	On Road Cargo Allowance	Off Road Cargo Allowance	Roof Allowance	Rack Weight
LDV D90	70kg / 154lb	46kg / 101lbs	75kg / 165lbs	5kg / 11lb
Colorado 7/ Trailblazer	95kg / 208lbs	63kg / 138lbs	100kg / 220lbs	5kg / 11lbs

Maximum roof load: 75kg/165lbs - 100kg/220lbs (vehicle dependant) evenly distributed across two crossbars. Refer to vehicle owners manual for maximum roof loading. Always use lower of the two figures. Note: Be sure to check Rhino-Rack website to see if you have the latest version of instructions before beginning installation.

Torque settings

Unless stated otherwise in these instructions, all fasteners should be set to the following torque settings -
M6: 4-5Nm (3-4lbs/ft), M8: 8-10Nm (6-7.5lbs/ft) and M10: 16-18Nm (12-13lbs/ft).

Recommendations:

It is essential that all bolt connections be checked after driving a short distance when you first install your crossbars. Bolt connections should be checked and lubricated at regular intervals (probably once a week is enough, depending on road conditions, usage, loads and distances travelled). You should also check the crossbars each time they are refitted. Make sure to fasten your load securely. Please ensure that all loads are evenly distributed and that the centre of gravity is kept as low as possible.

Crossbars must be removed when putting vehicle through an automatic car wash.

Use only non-stretch fastening ropes or straps.

Caution: The handling characteristics of the vehicle changes when you transport a load on the roof. For safety reasons we recommend you exercise extreme care when transporting wind-resistant loads. Special consideration must be taken into account when cornering and braking.

Off-road Load Rating:

When crossbars are to be used in off-road conditions, please use load limit for off-road use, 2 crossbars = **46kg / 101lbs - 63kg / 138lbs (vehicle dependant)**. Although the crossbars are tested and approved to AS1235-2000, off-road conditions can be much more rigorous. However, increasing the number of crossbars does not increase the vehicles maximum permissible roof loading.

Note for Dealers and Fitters:

It is your responsibility to ensure instructions are given to the end user or client.

Rhino-Rack

3 Pike Street, Rydalmere,

NSW 2116, Australia.

(Ph) (02) 9638 4744

(Fax) (02) 9638 4822

Document No: R1336

Prepared By: Kayle Everett

Authorised By: Chris Murty

Fit Time: 30min

Issue No: 03

Issue Date: 30/08/2018

These instructions remain the property of Rhino-Rack Australia Pty. Ltd. and may not be used or changed for any other purpose than intended.



RCP32-BK Holden Colorado 7 - Chevrolet Trailblazer - LDV D90

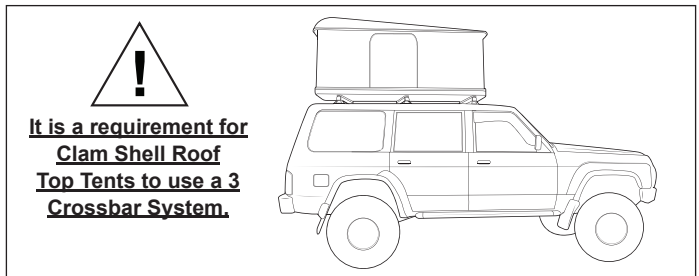
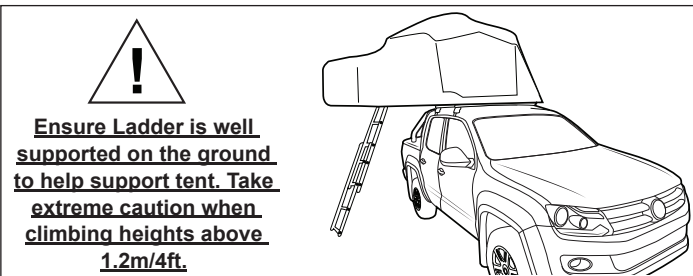
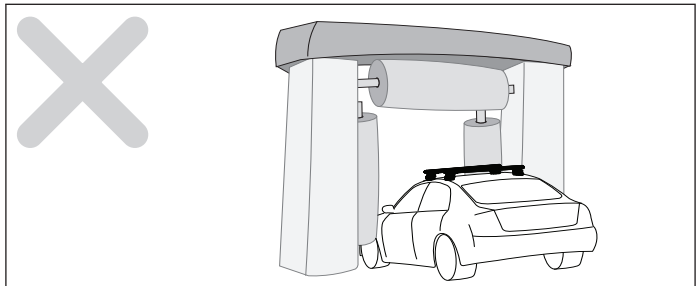
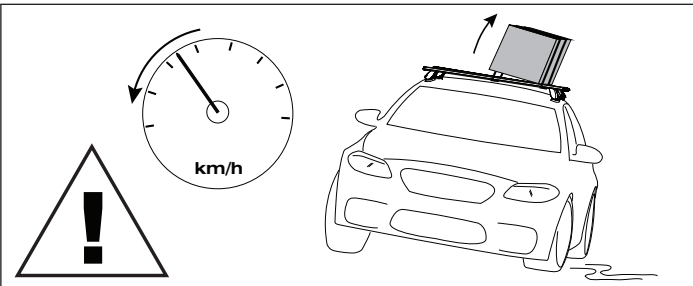
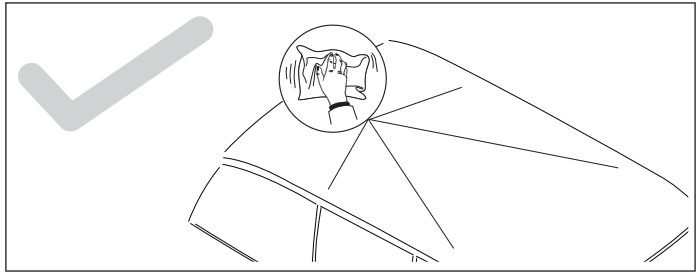
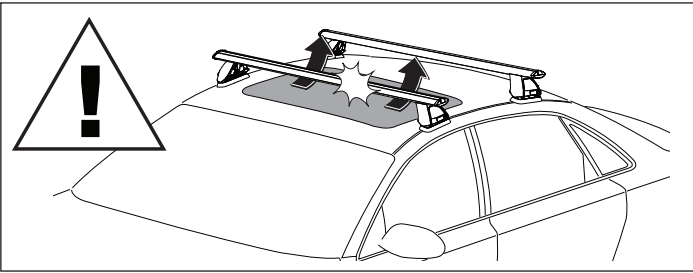
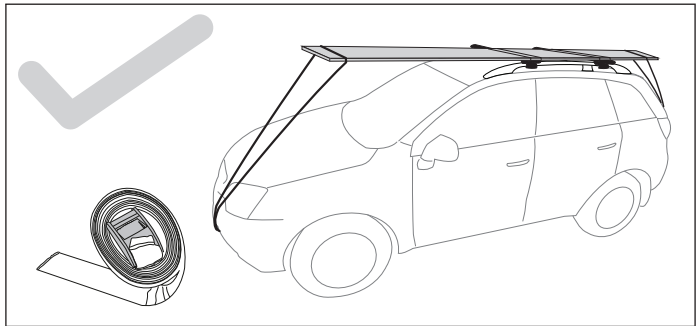
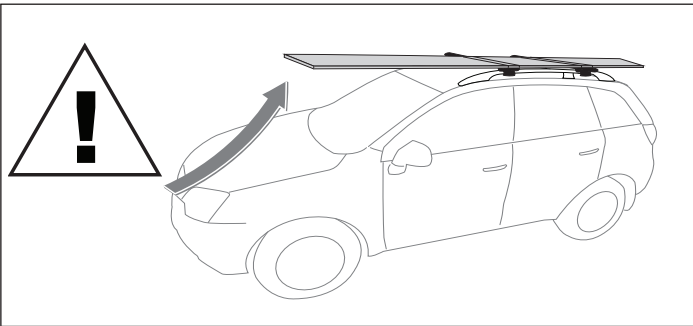

When these roof racks are to be used on a vehicle that is driven off sealed roads, the maximum roof rack load rating allowed divisible by a safety factor of 1.5.

LDV D90 70kg/154lbs load rating (Urban road)	=	46kg/101lbs load rating (Off road - 70kg / 1.5)
Colorado 7 / Trailblazer 95kg/208lbs load rating (Urban road)	=	63kg/138lbs load rating (Off road - 70kg / 1.5)

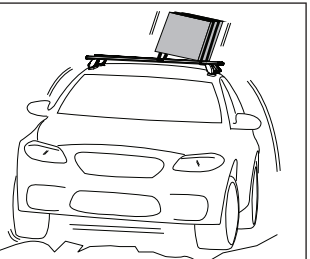

WARNING! Important Load Carrying Instructions

With utility vehicles, the cabin and the canopy move independently. Roof racks and vehicle can be damaged if the item transported is rigidly fixed at points on both the cabin and canopy. Instead, rigidly fix to either the cabin roof racks or the canopy roof racks.

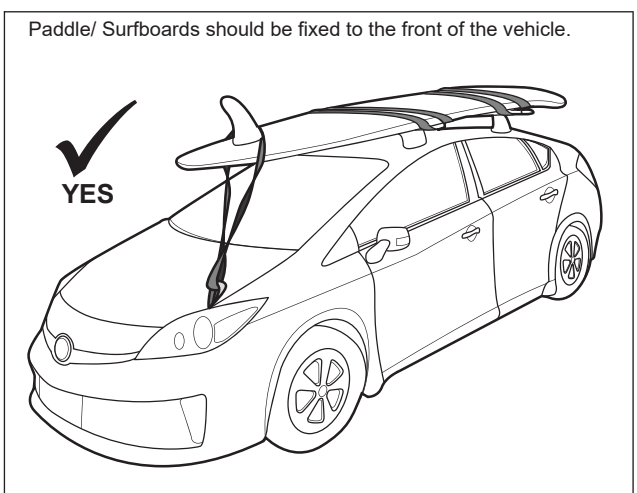



RCP32-BK Holden Colorado 7 - Chevrolet Trailblazer - LDV D90

Parts List

Item	Components	1 Bar	2 Bar	Part No.
1	RCP Bracket	2	4	CA1309
2	Colorado 7 Rubber Skirt	2	4	M725
3	Cover Plate	2	4	A763
4a	M6 x 16 Hex Setscrew	2	4	B168
4b	M6 x 16 Socket Screw	4	8	B031
5	M6 Spring washer	6	12	W004
6	M6 x 16mm Flat Washer	6	12	W031
7	5mm Security Allen Key	1	1	H021
8	M6 Washer (used on cover plate)	2	4	W003
9	Fitting Instructions	1	1	R1336

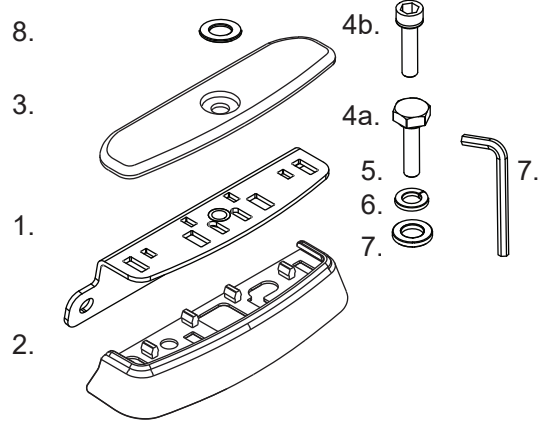

Instructions

- 1** Install the mounting bracket onto the gasket. Note that the four locking tabs on the gasket push through and fix onto the bracket.

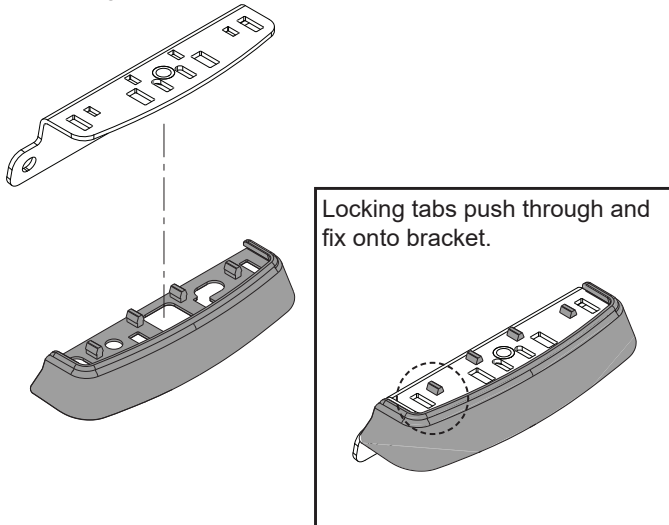

- 2** Install the completed mounting bracket onto the roof rails. Fixture points are located on both rails facing inward.

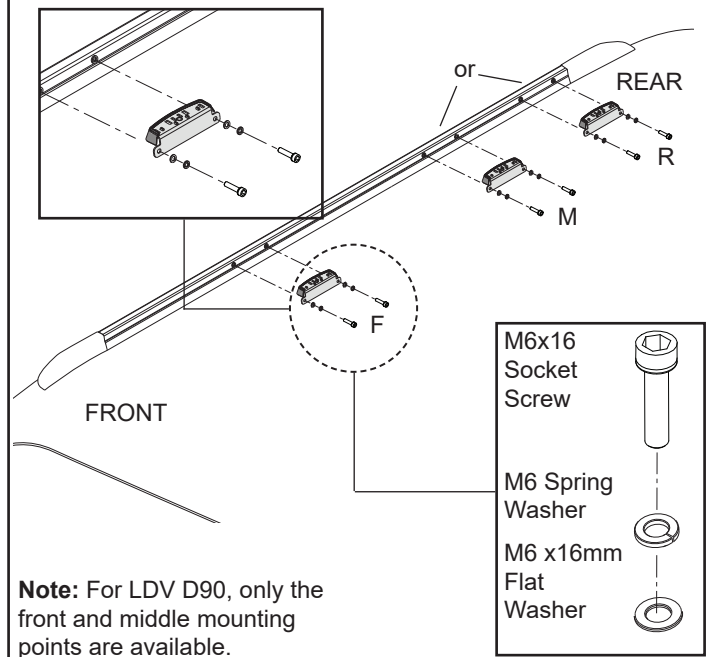

- 3** Fix the completed crossbars to the vehicle with an M6x16mm hex, M6 spring and flat washer (RVH shown as example only).

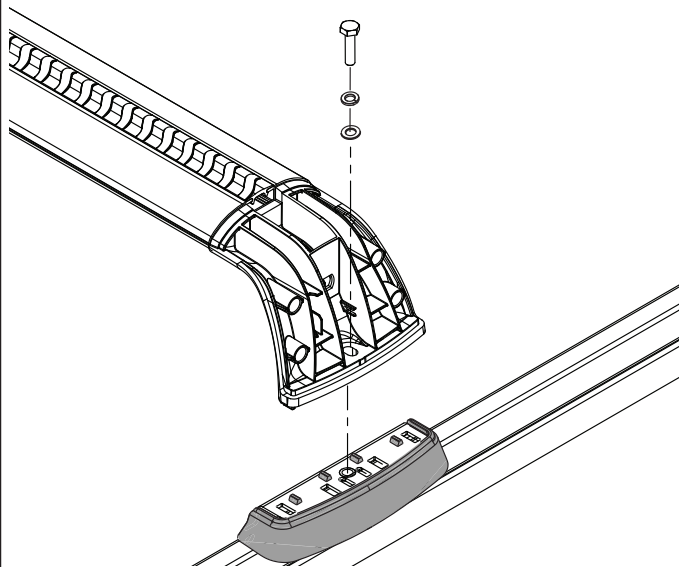

- 4** When crossbars are not in use, remove and install the cover plates as shown.

